



HM-TP22-3AQF/W-M20W

Handheld Thermal Camera

HIKMICRO M20W handheld thermography camera is specially designed for professional inspections of large objects where a wider FOV captures more of the scene in one picture. It's equipped with a 256 × 192 resolution thermal detector, 50° x 37.2° fixed focus lens, and an 8MP resolution visual camera. The high resolution 3.5-inch touch screen displays crisp, clear images and streamlines camera operations. Imaging modes include thermal, visual, picture in a picture of the optical and thermal view, and fusion of both channels. The M20W quickly identifies potential faults and quantifies the impact with accurate temperature measurement, provides detailed documentation to complete your inspections efficiently.

Key Features

- High sensitivity thermal module with 256 × 192 resolution
- Supports multiple palettes
- High quality optical module with 8 MP resolution
- Bi-spectrum image fusion, picture-in-picture preview
- Wide temperature measurement range: -20 to 550°C
- High temperature measurement accuracy: Max. ($\pm 2^{\circ}\text{C}/3.6^{\circ}\text{F}$, $\pm 2\%$), for ambient temperature 15°C to 35°C (59°F to 95°F) and object temperature above 0°C (32°F)
- High-calibre 640 × 480 resolution 3.5" LCD touch display
- Long-distance laser light supplement for thermography targets
- LED light supplement makes the device a torch in required scenarios
- Supports 1x, 2x, 4x and 8x digital continuous zoom
- Support remote album access, download and quick report with APP.

Specification

THERMAL MODE	
DETECTOR TYPE	Vanadium Oxide Uncooled Focal Plane Array
IR RESOLUTION	256 × 192 (49,152 pixels)
DETECTOR PITCH	12 μm
SPECTRAL RANGE	8 μm to 14 μm
NETD	< 40 mk (@25°C, F# = 1.0)
FOV (FIELD OF VIEW)	50° (H) × 37.2° (V)
IMAGE FREQUENCY	25 Hz
FOCAL LENGTH	3.6 mm
FOCUS	Fixed
MIN. FOCUSING DISTANCE	0.5 m
IFOV (SPATIAL RESOLUTION)	3.33 mrad
APERTURE	F1.0
OPTICAL MODE	
BUILT-IN VISUAL CAMERA	3264 × 2448 (8 MP)
FOCUS	Fixed
FOV (FIELD OF VIEW)	65° (H) × 51° (V)
PICTURE RESOLUTION	3264 × 2448 (8MP)
VIDEO RESOLUTION	1600 × 1200
IMAGE DISPLAY	
DISPLAY	Display 640 × 480 Resolution, 3.5" LCD Touch Screen
SCREEN BRIGHTNESS	Manual
DIGITAL ZOOM	Continuous zoom 1x, 2x, 4x, 8x
COLOR PALETTES	White Hot, Black Hot, Rainbow, Ironbow, Red Hot, Fusion, Rain
IMAGE MODES	Thermal/Optical/Fusion/PIP
PIP	Thermal Picture in Optical Picture
FUSION	Thermal Picture and Optical Picture Combined
LEVEL/ SPAN	Auto/Manual
MINIMUM TEMP SPAN (MANUAL)	2°C (3.6°F)
MEASUREMENT AND ANALYSIS	
OBJECT TEMPERATURE RANGE	-20°C to 550°C (-4°F to 1022°F)

ACCURACY	Max. ($\pm 2^{\circ}\text{C}/3.6^{\circ}\text{F}$, $\pm 2\%$), for ambient temperature 15°C to 35°C (59°F to 95°F) and object temperature above 0°C (32°F)
MEASUREMENT PRESETS	Center Spot, Hot Spot, Cold Spot, Off
USER-DEFINED MEASUREMENT POINTS	10 points
USER-DEFINED MEASUREMENT LINES	1 line with max./min./avg. temperature
USER-DEFINED MEASUREMENT AREAS	3 areas with max./min./avg. temperature
HIGH TEMPERATURE ALARM	Audible Warning
COLOR ALARM (ISOTHERM)	Above/Below/Interval/Insulation
FOCUS-MODE PALETTES	Above/Below/Interval
ON-CAMERA EMISSIVITY CORRECTION	Variable from 0.01 to 1.0 or selected from the materials list
ON-CAMERA REFLECTED TEMPERATURE COMPENSATION	Automatic, based on the input of the reflected temperature
ON-CAMERA TRANSMISSION CORRECTION	Automatic, based on the inputs for distance and humidity
STORAGE	
STORAGE MEDIA	Default Storage: Removable SD Card (16 GB); Max. Storage Capacity: 128 GB
IMAGE STORAGE CAPACITY	60,000 Images
IMAGE FILE FORMAT	Radiometric image with Measurement Data Included
VOICE NOTE	Max. 60 Seconds
TEXT NOTE	Max. 200 Characters
VIDEO STORAGE CAPACITY	60 Hours
VIDEO FILE FORMAT	Standard MP4 non-radiometric video
POWER SYSTEM	
POWER SUPPLY	12 VDC/1.5 A, 5 VDC/2A (Charging via USB)
POWER CONSUMPTION	4.6 W
BATTERY TYPE	Dismountable and Rechargeable Li-ion Battery
BATTERY OPERATING TIME	6 Hours Continuous Running
BATTERY CHARGING TIME	4 hours to full charge
BATTERY CHARGING SYSTEM	Two-bay battery charger or in-imager charging, fast charging
AC OPERATION	AC operation with included power supply (100 VAC to 240 VAC, 50/60 Hz)
GENERAL	
WI-FI	802.11 b/g/n (2.4 GHz and 5 GHz)

BLUETOOTH	Bluetooth 4.2
USB INTERFACE	USB Type-C
SD CARD INTERFACE	Micro SD card slot
LED LIGHT (TORCH)	Yes
LASER POINTER	Yes
LASER TYPE	Class II, Wavelength: 635 nm; Power: < 1 mW
PROTECTION LEVEL	IP54
DROP TEST HEIGHT	2 m (6.56 ft)
WARRANTY	3 years for full product, 10 years for detector, and 2 years for battery
RECOMMENDED CALIBRATION CYCLE	1 year (assumes normal operation and normal aging)
SAFETY	IEC 61010-1: Overvoltage category II, Pollution Degree 2
ELECTROMAGNETIC COMPATIBILITY	EN 55032: 2015+A11: 2020 EN 50130-4: 2011+A1: 2014 EN 61000-3-3: 2013 EN IEC 61000-3-2: 2019+A1: 2021
AUSTRALIAN RCM	EN 55032: 2015+A11: 2020 EN IEC 61000-3-2: 2019+A1: 2021 EN 61000-3-3: 2013+A1: 2019 EN 301 489-1 V2.2.3 EN 301 489-3 V2.1.1 EN 301 489-17 V3.2.4 EN 300 328-V2.2.2 EN 301 440-V2.1.1 EN 301 893-V2.1.1 EN 62479: 2010
US FCC	CFR 47, Part 15 Subpart C
ROHS COMPLIANT	Yes
VIBRATION	0.03 g2/Hz (3.8 g), 2.5 g IEC 60068-2-6
SHOCK	25 g, IEC 68-2-29
WORKING TEMPERATURE RANGE	-10°C to 50°C (14°F to 122°F)
STORAGE TEMPERATURE RANGE	-20°C to 70°C (-4°F to 158°F)
RELATIVE HUMIDITY	5% to 95%
WEIGHT	Approx. 660 g (1.46 lb)
DIMENSION	244 mm × 100 mm × 104 mm (9.61" × 3.94" × 4.09")
TRIPOD MOUNTING	UNC ¼"-20
MENU LANGUAGE	21 Languages

	English, German, French, Spanish (Spain), Portuguese (Portugal), Italian, Czech, Slovak, Polish, Hungarian, Romanian, Dutch, Danish, Norwegian, Finnish, Swedish, Russian, Turkish, Japanese, Korean, Chinese (Traditional)
SOFTWARE	
PC SOFTWARE	HIKMICRO Analyzer
APP	HIKMICRO Viewer App
CAST SCREEN	UVC Alarm Client

Please note that product specifications are subject to change without notice. Please check <https://www.hikmicrotech.com> for the latest changes.

Ordering Model

HM-TP22-3AQF/W-M20W

Dimension

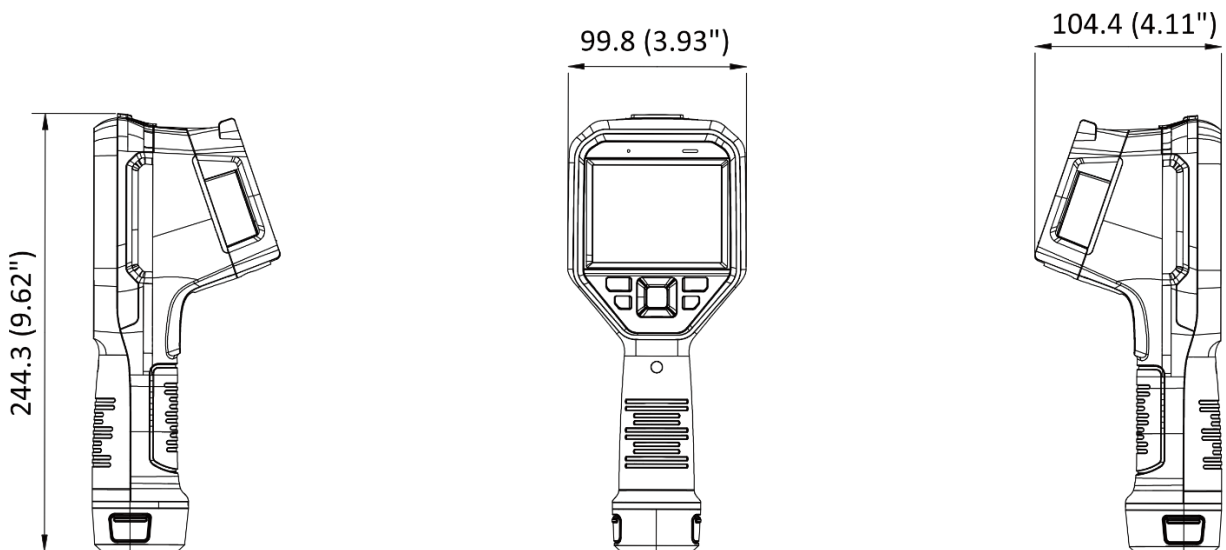

Unit: mm (Inch)

Packing List

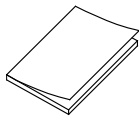

QSG (× 1)

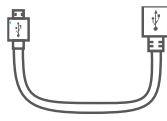

USB 2.0 A to USB Type-C
Cable (× 1)



Power Supply for
Battery Charger (× 1)

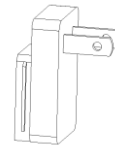

International Use
Plugs (US/EU/UK/AU)
for Power Supply

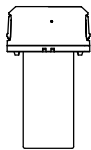

Battery (× 2)

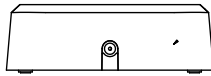

Two-bay Battery Charger (×
1)

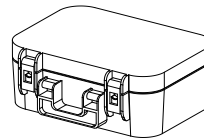

Hard Carrying Case (×
1)

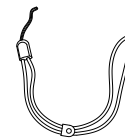

Wrist Strap (× 1)

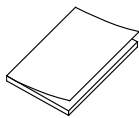

Calibration Certificate
(× 1)

COMPLIANCE NOTICE: The thermal series products might be subject to export controls in various countries or regions, including without limitation, the United States, European Union, United Kingdom and/or other member countries of the Wassenaar Arrangement. Please consult your professional legal or compliance expert or local government authorities for any necessary export license requirements if you intend to transfer, export, re-export the thermal series products between different countries.



Distribué par ZA Mâcon Est - Les Brosses
01750 REPLONGES - 03 85 31 89 10

